

CORPORATE CATALOGUE



CONNEXUS
INDUSTRIES INC
Chain & Industrial Manufactured Solutions





LANGLEY, BRITISH COLUMBIA



SAINT-NICOLAS, QUEBEC



ATLANTA, GEORGIA

**LANGLEY
BRITISH COLUMBIA**

27474 Gloucester Way, Langley BC, Canada V4W 4A1
† 604.882.1602 toll free 1.800.324.1244

**SAINT-NICOLAS
QUEBEC**

11194 Chem. Industriel #108 Saint-Nicolas, QC G7A 1B1
† 418.834.5116 toll free 1.888.650.6090

**ATLANTA
GEORGIA**

3411 Novis Pointe, Acworth, GA, USA 30101
† 678.797.0777 toll free 1.877.941.1500



Branches **2**

Table of Contents **3**

About Us **4**

Connexus Brands **5**

Chain Line-up **6**

Sharp Top Chains™ **7**

Connexus - l’anco Cast Chains **8**

Connexus - l’Anco Products **9**

Connexus Chains **10 - 11**

Connexus Lasers **12 - 13**

Connexus Non-Metallic Chains **14**

Metal Detectors **15**

Lazer Tracker **16**

Environmental **17 - 19**



Connexus Industries, where history meets innovation. With a legacy dating back to the late 1920s, our family of companies has been at the forefront of delivering excellence to various industries.

Beginning with l'Anco in 1927, we forged our path as a pattern shop and later evolved into producing equipment for the logging industry, with our cast alloy chains still preferred more than 80 years later. Lacey Harmer, established in 1935, has been a trusted supplier to the logging industry and introduced the world to the renowned Sharp Top Chain™ and Summit® product range. In the early 1990s, Viking Chains emerged as a reliable source for quality chains, especially in applications like Wastewater Treatment.

Connexus Industries, brings nearly a century of combined expertise to provide you with products that have been the cornerstone of industries for decades. Our commitment is to meet and exceed your expectations, ensuring that we remain your partner of choice.

Explore our product catalogue and discover the legacy, quality, and innovation that define Connexus Industries.

Rudi Pieterse

President & General Manager
Connexus Industries





These products are all exclusively manufactured for or by Connexus Industries

CHAIN



LASER PRODUCTS



METAL DETECTION



ENVIRONMENTAL





STAINLESS STEEL CHAIN

Designed for food applications and in areas where wash-down, steam, and chemicals are prevalent.



DRAG CHAIN

Provide efficient means to convey sawdust, chips or bark dust. Long run life in slow speed applications.



81X ENGINEERING CLASS CHAIN

Generally used for slow to moderate speed drives and conveyor applications. Common attachments include bullnose UHMW, plastic caps, camelbacks, trimmer lugs and pusher lugs.



AGRICULTURAL CLASS CHAIN

Designed to withstand the harsh environment of the agriculture industry. Long lasting, with less maintenance.



DOUBLE FLEX CHAIN

Designed for conveying applications where bend radius is required for material flow change of direction.



SHARP TOP CHAIN®

Excellent solution to increase feed speeds. Available in numerous tooth profile designs. Number one choice of original equipment manufacturers.



LEAF CHAIN

Leaf chain is used for applications that require strong flexible linkage for transmitting motion or lift.



POWER TRANSMISSION CHAIN

Designed to provide a flexible means of power transmission. Available in both offset and straight sidebar configuration.



WELDED STEEL MILL CHAIN

Specifically designed to provide efficient means to convey product in today's most difficult material handling applications. Welded attachments are available in numerous styles.



ROLLER CHAIN

Ideal for industrial and agriculture applications. Plates and rollers are shot peened and preß^o-stretched at factory for greater strength and longer life.

CONNEXUS SHARP TOP CHAINS™



SHARP CHAIN



The endless push to raise sawmill productivity constantly demands higher speed, greater accuracy and less waste. Connexus Sharp Top Chains™ can play a role in your mill's profitability by performing better and lasting longer.

We start with superior design. We determine the exact degree of tip sharpness to work best for each application, creating maximum grip with minimum penetration and tear out. The result is a chain that runs accurately at speeds of over 1,400 FPM.

INNOVATION



Superior design demands superior material and fabrication. Connexus Sharp Top Chains™ products are made of top grade material to provide the greater hardness necessary to resist corrosion and oxidation while maintaining strength at high temperatures. Connexus Sharp Top Chains™ offers precision ground flat bottom chains that reduces wear and damage to your chain bed and distributes load evenly. Our chains are fine blanked with low draft tooth profile that distributes weight and reduces losses from bruising. We manufacture Connexus Sharp Top Chains™ with the closest possible tolerances in the industry and offer a unique solid center plate design that all but eliminates breakage from sawdust packing.



MILL CHAIN

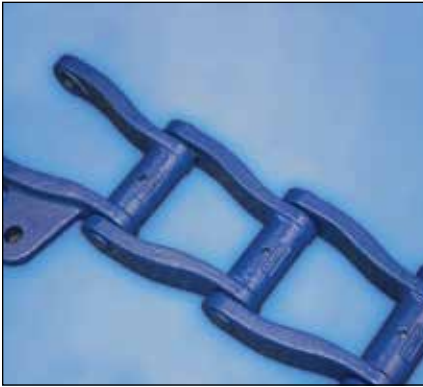

I'Anco Cast alloy steel and Hadfield manganese steel mill chains are designed for the most severe service applications in wood processing facilities today. They are designed to handle extreme wear, high tensile loads and extreme impact. Our ability cast attachments integral to the link eliminates any chance of creating heat affected zones by welding; however, the materials are readily weldable allowing for quick turnaround times for custom attachments. All of our cast links have recessed head and rivet ends offering protection from side wear on the rivets. This also allows us to pour the links with heavier cross sections adding to the overall strength of the chains plus creating larger bearing surfaces to distribute the loads over a larger area reducing the wear on the side bars.

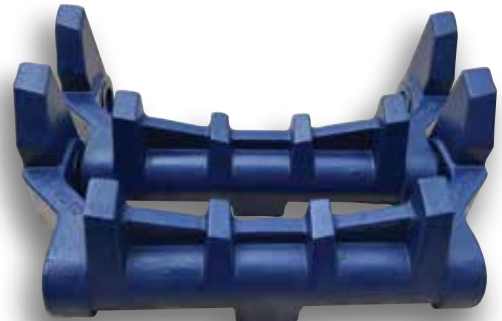

TRACK PADS

Connexus has been manufacturing track pads for underground mining and harvesting equipment for over 15 years. Materials range from mild steel to MT100 special alloy steel and cover hardness values of 160-340 BHN. The weights range from 20 lbs to over 300 lbs and could go even higher. During the final phase of construction the pads are assembled and tested to ensure articulation is smooth and complete eliminating the possibility of jams and locking up around the drive sprocket.

SHREDDER PARTS

Connexus manufactures and stocks a wide variety of parts to suit specific machines. Our design department has carefully selected the right material composition and hardness to increase the service life of our parts and minimize downtime. The materials we use range from quenched and tempered low alloy steels to Hadfield Manganese and Stainless Steels. We commonly use tungsten carbide chip deposits in hard facing weld materials to further increase the service life of our parts.

We have an extensive list of products currently in production; however, if we don't have what you need, we have the ability to produce your requirements in low or high volumes at competitive prices.

DRAG CHAIN

The CXS - I'Anco line of traditional Clinker drag chains is available in cast manganese and alloy steels; however, they have also been adapted to high temperature applications for kiln discharge conveyors operating at 1,800°-2,000° F. For these applications high temperature stainless steels are utilized. In conjunction with the drag chains, Connexus offers custom liners for conveyors that take into account the operating parameters so the best material can be selected for the application. Liners are available in manganese, alloy and tool steels plus high temperature cast iron or 25% Chrome Iron, other materials can be supplied for the specific challenges found in your conveyor.



WELDED STEEL CHAIN

- Full press fit rivets
- Parallel sidebar holes
- High quality material & heat treating

WELDED STEEL PLUS

- Welded flush on outside eliminates any interference with sprockets
- Parallel holes for "true-fit"
- Seamless barrels eliminate "premature stretch"

WELDED STEEL DRAG CHAIN

- Fully heat treated barrels
- Full press fit rivets
- Parallel sidebar holes
- High quality material & heat treating

DOUBLE LENGTH INFEEED CHAINS, SCANNING CHAINS, FLIGHTS, SPROCKETS AND BEDPLATES

- Specifically constructed to withstand high speed, impact applications
- Industry leader for 25 plus years
- Custom solutions

SUGAR MILL CHAINS

- Designed for long service life in sugar mill applications
- Heat treated stainless steel, hard chrome options available
- Standard and custom attachments

SPECIALTY CHAINS FOR ALL MARKETS

The consolidation of Viking Chains Group into **Connexus Industries** has allowed the continuation of the VC Brand of Steel Chains. The VC Brand says quality manufacturing process, and long service life. This successful brand includes the following:

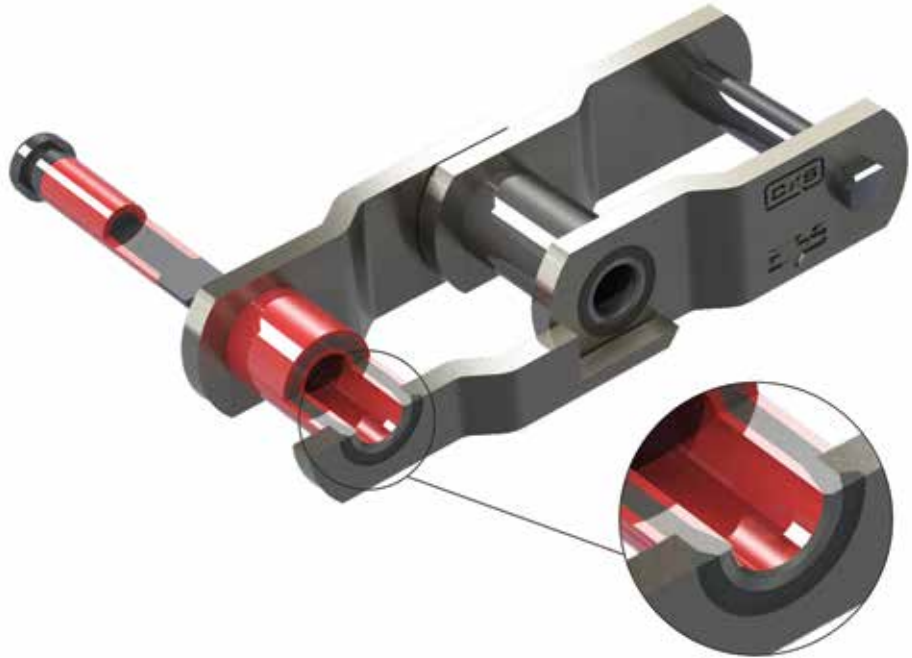

CEMENT & ASPHALT PLANT CHAINS

- Bucket Elevator Chains
- Reclaimer Chains
- Hot Lime & Clinker Chains

CXS - Connexus Chains are engineered, designed and manufactured to ISO9001:2008 standards to meet the highest industry specifications.

Material selection, manufacturing tolerances and controlled heat treating are the most important criteria for constructing chains designed for long service life in arduous applications.

Connexus Industries, the consolidation of Viking Chains Inc, l'Anco Products and Lacey Harmer Inc. bring together decades of industry experience, and practical knowhow.

SUGAR MILL CHAINS

- Cane Feed & Washing Table Chains
- Main Cane Carrier Chains
- Bagasse Carrier Chains
- Ash Removal Chains



PULP & PAPER CHAINS

- Specialty Floor Chains
- Flanged Wheel Steel
- Bushed Pan Chain



POWER PLANT CHAINS

- Screen Chains
- Stainless Steel
- Heavy Duty Drive Chains



LAHARCO

CONNEXUS INDUSTRIES (formerly Lacey-Harmer) is a true pioneer in the development of laser guideline manufacturing in North America. Dedication to quality and customer service has enabled us to maintain our position as one of the leaders in this industry.

LASER BLAZER®

Laser manufacturing began in 1979. In 1989, driven by customer application requirements, we began manufacturing optical elements. This has allowed Lacey-Harmer to develop a wide range of diverse and unique products.

LASALIGN®

We proudly serve the wood products, metal working, stone, and food processing industries, among many others, where accurate cutting is crucial to productivity.



Lacey-Harmer produces a variety of brackets to meet specific applications



Stainless Steel Uni-bracket



Uni-bracket



Tilt bracket



GTD bracket

DIODE LASERS

- 5 mW
- 10 mW
- 15 mW
- 20 mW



LAHARCO
End Shooter



LAHARCO
Side Shooter

- 5 mW
- 10 mW
- 15 mW
- 20 mW



LASER BLAZER DOT



E-LINE
End Shooter

- 10 mW
- 15 mW
- 30 mW



GTD - RAM
End Shooter



GTD - RAM
Side Shooter

HeNe LASERS

- 5 mW
- 10 mW
- 17 mW



MODEL 77A LASER BLAZER
End Shooter



MODEL 8201-AI
Side Shooter

Units Available in 12v, 110v, 220v



Pivot bracket



Slide bracket



HeNe adjustable mounting bracket



- **BOTTLING PLANTS**
- **FOOD PROCESSING**
- **DAIRIES**
- **BAKERIES**
- **BUCKET ELEVATORS**
- **AGRICULTURE**
- **WASTEWATER**
- **PHARMACEUTICALS**
- **CLEAN WATER**
- **FISH PROCESSING**
- **PACKAGING**

Whether the need is to transport raw goods through the harvesting and sorting process, or the finished goods after packing, our chains are designed for long life and minimal maintenance in both wet and dry environments.

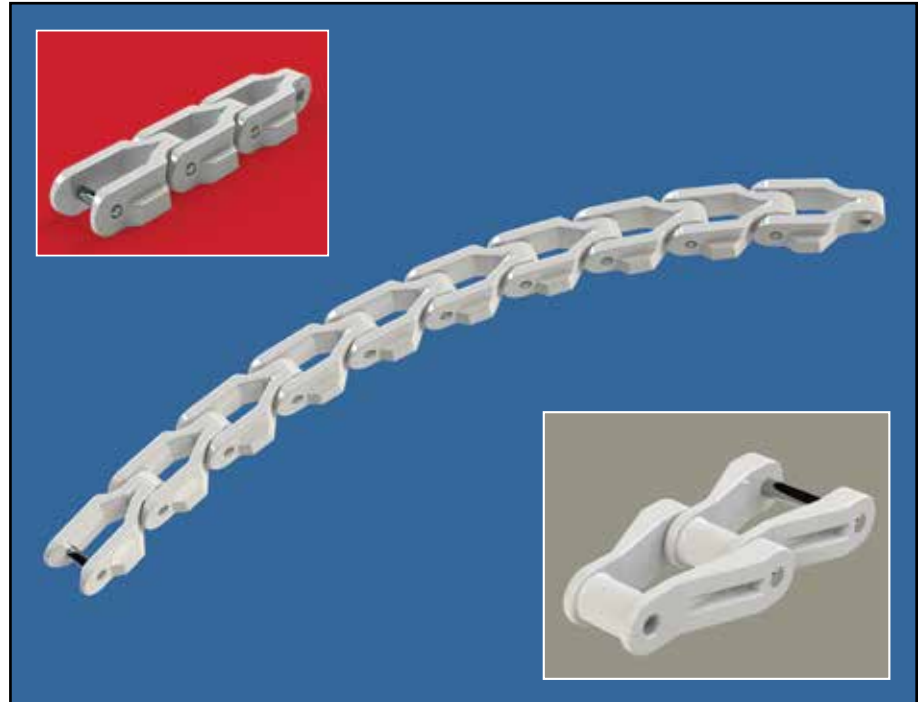

METAL SHARK



METAL SHARK Metal Shark is the best in the metal detection business. Whether your

application requires detecting a nail in a whole log or a needle in a stack of denim, Metal Shark has the metal detector to handle your requirements. Manufacturing the most technologically advanced metal detectors on the market is our specialty. By using exclusive 4 channel DDS and DSP microprocessor technology we achieve continuous accuracy and absolute stability.

Whole Log, Cant, Belt, Vibrating Conveyors, OSB and Fluff Pulp applications are our specialty.

Industries served range from solid wood, OSB, pulp and paper, recycling and food.

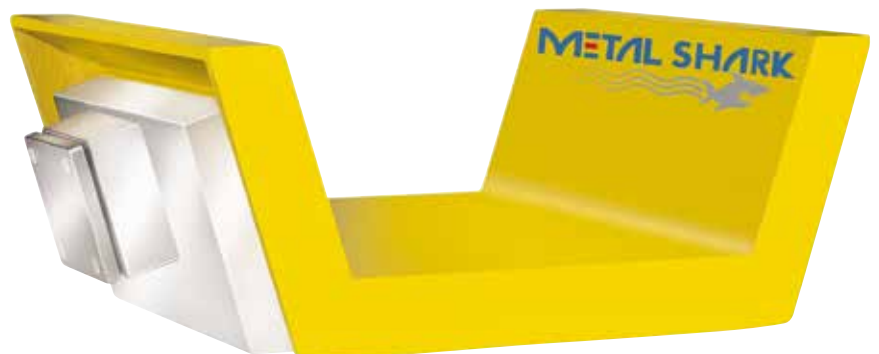

LAZER TRACKER™ Fork Tip Guidance System

- Creates a safer environment while adding to your bottom line
- System can be set to remember your pre-set level
- Long life battery or hard wire option
- Meets OSHA guidelines

Connexus **LAZER TRACKER™** is the single most effective material handling tool that addresses issues of controlling product damage, increasing productivity, and creating a safer work environment. The guidance system will assist the forklift operator in pinpoint accuracy of fork tip placement. Mounted on the forklift carriage between the forks the **LAZER TRACKER™** casts out a horizontal beam that is aligned to the tips of each fork. This allows the operator to see exactly where the forks are at all times.



Pinpoint accuracy of fork tip placement. Decrease property damage, increase productivity & safety





SYSTEM INTEGRATORS



VIKING ENGINEERED CHAIN & FLIGHT SYSTEMS



OUR QUALITY PRODUCTS

Our Quality products include:

- Chain
- Sprockets
- Flights
- Wear Shoes
- Filler Blocks
- Wear Strips
- Set Collars
- Return Rails
- Bearings, Shafts
- Static Sleeve Bushings
- Drive Units

Practically every consumable in:

- Clarifiers
- Grit Channels
- Bar Screens
- Traveling Water Screens for all water and waste water applications are supplied by Viking Chains

NON METALLIC COLLECTOR CHAIN



STAINLESS STEEL COLLECTOR CHAIN

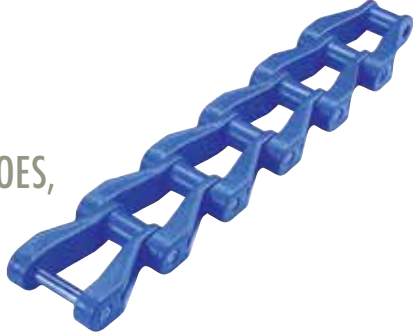

FLIGHTS, WEAR SHOES, FILLER BLOCKS



FLIGHT HARDWARE

NON METALLIC DRIVE CHAIN



STAINLESS STEEL DRIVE CHAIN

SPROCKETS, BEARINGS



BAR SCREENS & BAR SCREEN CHAIN

MEGA CHAIN

www.cnxsind.com

ADDITIONAL EQUIPMENT AVAILABLE FOR RECTANGULAR CLARIFIERS, BAR SCREENS AND GRIT COLLECTORS:

- Chain and Attachments
- Drive chains
- Flights
- Filler Blocks
- Wear Materials
- Hardware
- Sprockets
- Wall Bearings
- Return Rails
- Shafts
- Drive Units

VIKING CHAINS PULTRUDED FIBERGLASS FLIGHTS COME IN THREE STYLES:

- Standard "C" channel
- Ultra flight
- Heavy duty super flight

The C channel flight is offered in a standard 6" or 8" version, and the Ultra flight and heavy duty super flight is offered in a standard 8" version.

VIKING CHAINS ALUMINUM FLIGHTS are made from 6063-T5 Aluminum and provide a cost effective alternative to fiberglass flights. The flights unique patented design allows the attachments and wear shoes to be bolted to the flight without drilling holes or notching the flight. This is done by the slots running the full length of the flight. The aluminum flight is offered in a standard 8" version.

BENEFITS OF THE ALUMINUM FLIGHTS:

- Lightweight for easy installation
- No need for filler blocks
- No notching or drilling required
- Can be completely assembled in advance with minor field adjustments
- Can be repaired and welded on-site or in a shop
- Can be RECYCLED for salvage value after use.

As an option, rubber scrapers can be added to the flights

VIKING CHAINS SPROCKETS

All UHMW & UHMW Segmental Rims are lightweight for easy installation and change out. All fittings supplied in SS304 or SS316.

Viking 720 Series molded chain saver rim sprockets come with UHMW-PE sprocket rims and glass filled co-polymer hubs. Our unique ability to combine more than one material in a single sprocket allows us to utilize the desirable characteristics of each of the engineered plastics to maximize service life.

Combination rims can be reserved for extra wear. Easy installation and change out. Stands up to harsh environments and high grit applications.

OTHER SPROCKET MATERIALS AVAILABLE: Nylon, Polyurethane, UHMW, Cast Iron Chilled Rim, Cast Iron c/w replaceable UHMW sprocket rims

orders@cnxsind.com

NON METALLIC COLLECTOR CHAIN



STAINLESS STEEL COLLECTOR CHAIN

FLIGHTS, WEAR SHOES, FILLER BLOCKS

FLIGHT HARDWARE



NON METALLIC DRIVE CHAIN

STAINLESS STEEL DRIVE CHAIN

SPROCKETS, BEARINGS

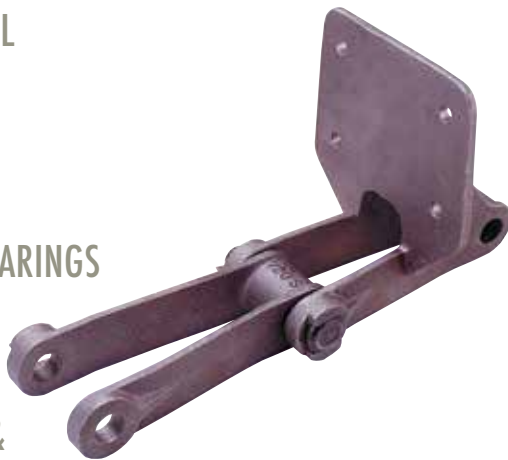

BAR SCREENS & BAR SCREEN CHAIN

MEGA CHAIN

VC720-PMI VIKING PEARLITIC MALLEABLE IRON COLLECTOR CHAIN

VC720-PMI Viking Pearlitic Malleable Iron Collector Chain offers maximum strength in harsh environments. This chain is interchangeable with other chains manufactured under ANSI standards. Heat treated pin and 304 stainless steel cotter supplied specifically for wastewater applications.

VCSS700 VIKING STAINLESS STEEL COLLECTOR CHAIN

VCSS700 Viking Stainless Steel Collector Chain is a lightweight, but high strength chain designed to withstand highly corrosive environments. Provides superior performance in long length clarifiers with high load and longer chain life in high grit and abrasive environments.

VCH78-PMI VIKING PEARLITIC MALLEABLE IRON DRIVE CHAIN

VCH78-PMI Viking Pearlitic Malleable Iron Drive Chain offers maximum strength in harsh environments. This chain is interchangeable with other chains manufactured under ANSI standards. Heat treated pin and 304 stainless steel cotter supplied specifically for wastewater applications.

WATER SCREEN CHAIN • BAR SCREEN CHAIN • CUSTOM STAINLESS STEEL CHAINS

Viking Chains manufactures numerous versions of water screen chains. From all parts made of 316SS and 17-4-PH stainless steel for highly corrosive applications to a combination of heat treated alloy steel, nylon and stainless steel components; we can meet all your needs for water screen chains. stainless steel bar screen chain and custom chains for wastewater or recycling applications are our specialty. Viking Chains manufactures many chains that are private branded for numerous OEM customers.

VC720NM VIKING NON METALLIC COLLECTOR CHAIN

VC720NM Viking non metallic collector chain is lightweight and designed for easy installation. This chain is compatible with other chain manufacturer's non-metallic sprockets and components.

VC78NM VIKING NON METALLIC DRIVE CHAIN

VC78NM Viking non metallic drive chain is designed to run in both directions. Viking's easy to assemble, unique locking pins and "D" head hold the SS304 rivets from rotating. Excellent performance in applications requiring high wear ability and chain strength.

WEAR MATERIALS

Wear Materials are lightweight and designed for easy installation. Components promote smooth and efficient operation allowing for extended system equipment life.



INDUSTRIES INC

Chain & Industrial Manufactured Solutions

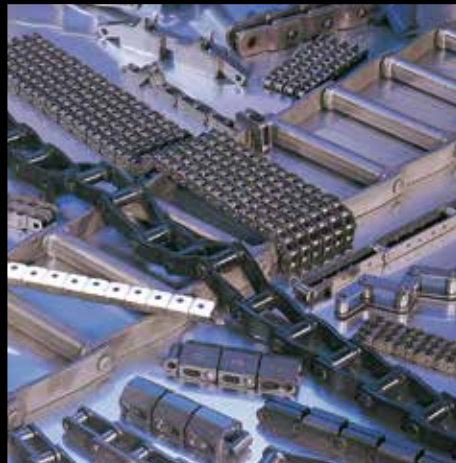
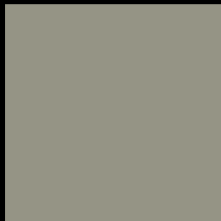

LANGLEY
BRITISH COLUMBIA

27474 Gloucester Way, Langley BC, Canada V4W 4A1
† 604.882.1602 toll free 1.800.324.1244

SAINT-NICOLAS
QUEBEC

11194 Chem. Industriel #108 Saint-Nicolas, QC G7A 1B1
† 418.834.5116 toll free 1.888.650.6090

ATLANTA
GEORGIA

3411 Novis Pointe, Acworth, GA, USA 30101
† 678.797.0777 toll free 1.877.941.1500

www.cnxsind.com